

(SEE A.C. WIRING DIAGRAM)

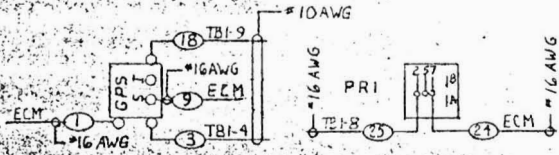

**CONTROL CABINET REAR
(FRONT VIEW)**

CUSTOMER CONNECTIONS

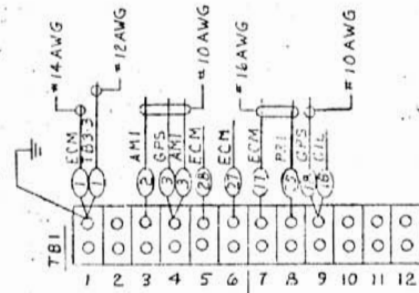
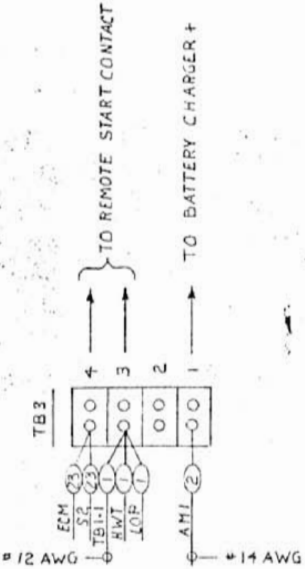
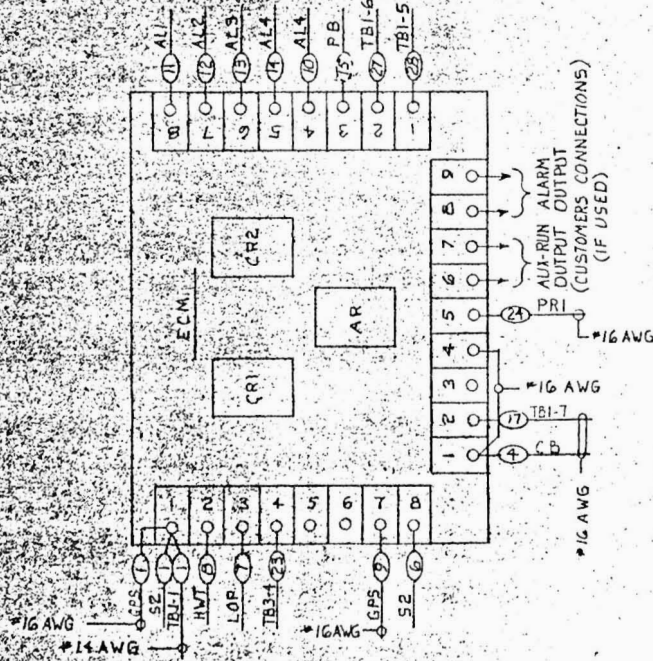

**WIRING TO ENGINE
(SEE ENGINE CONNECTION
DIAGRAM.)**

CONTROL CABINET FLOOR

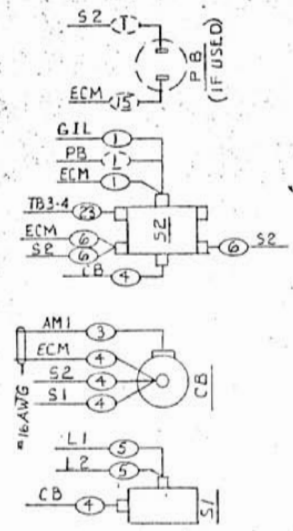

**CONTROL CABINET FRONT
(REAR VIEW)**

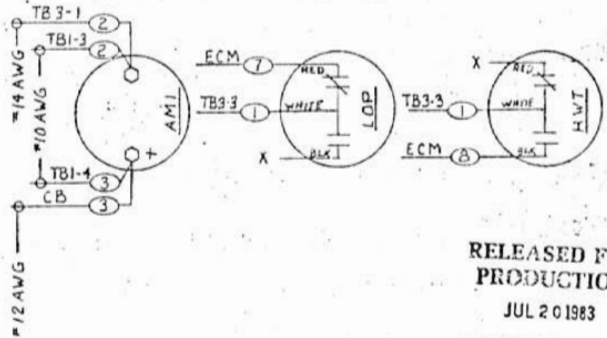
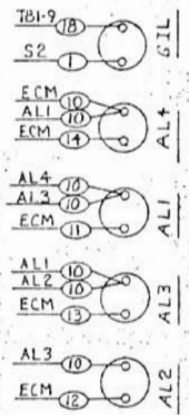

**RELEASED FOR
PRODUCTION**

JUL 20 1983

DYNA TECHNOLOGY, INC

NOTES:

1. EXCEPT AS NOTED ALL WIRES TO BE #20 AWG

ALL DIMENSIONS GIVEN IN INCHES - WORK TO DIMENSIONS - DON'T SCALE - SAMPLE MUST APPROVED BY DYNA TECHNOLOGY ENGINEERING DEPT. BEFORE PROCEEDING WITH PRODUCTION - TOLERANCES (UNLESS OTHERWISE SPECIFIED): FRACTIONS 2/104 DECIMALS .005 PUNCHED HOLES .004 - .000 ANGLES ± 1°

DRAWN BY	DATE	DATE	DATE	DATE	DATE
D. M. W.	6-24-83				
MATERIAL					
FINISH					
ASSY					
MODEL					

C-71521-11
D. C. WIRING DIAGRAM