

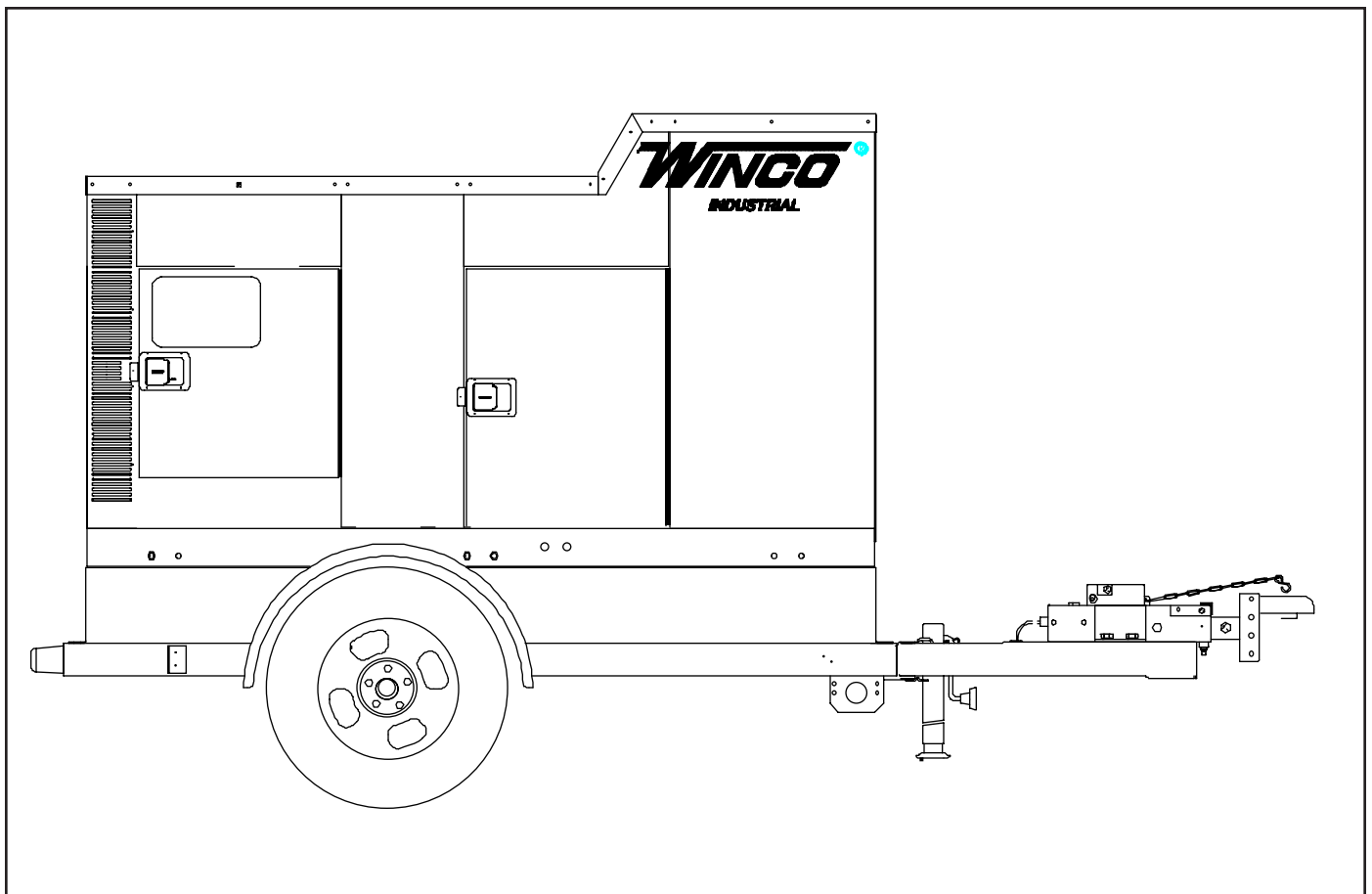

*Mobile Diesel
Systems*

**OWNERS
MANUAL**

MDS50



INSTALLATION AND OPERATION MANUAL

Read and understand all instructions in the manual before starting and operating the generator set.

USING THIS MANUAL

Congratulations on your choice of a Winco generator set. You have selected a high-quality, precision-engineered generator set designed and tested to give you years of satisfactory portable service.

To get the best performance from your new engine generator set, it is important that you carefully read and follow the operating instructions in this manual.

Should you experience a problem please follow the "Things To Check" near the end of this manual. The warranty listed in this manual describes what you can expect from WINCO should you need service assistance in the future.

PROPER USE AND INSTALLATION

You must be sure your new engine generator set is:

- * Properly serviced before starting
- * Operated in a well ventilated area
- * Exhaust gases are dispersed safely
- * Wired by a qualified electrician
- * Operated only for its designed purposes
- * Used only by operators who understand its operation
- * Properly maintained

COPY YOUR MODEL AND SERIAL NUMBER BELOW FOR FUTURE REFERENCE.

No other WINCO generator has the same serial number as yours. It is important that you record the number and other vital information here, if you should ever need to contact us on this unit it will help us to respond to your needs faster.

MODEL _____

SERIAL NUMBER _____

PURCHASE DATE _____

DEALER _____

TABLE OF CONTENTS

PRODUCT SAFETY	1
SPECIFICATIONS	2
PREPARATION	
UNPACKING	2
OIL REQUIREMENTS	2
FUEL REQUIREMENTS	2
COOLANT REQUIREMENTS	3
BATTERY CONNECTIONS	3
OPERATIONS	
FRONT PANEL DESCRIPTION	3
RECEPTACLE AND BREAKERS	4
FULL POWER CONNECTIONS	5
ENGINE CONTROL MODULE	5
VOLTAGE REGULATOR	6
SELECTING THE CORRECT VOLTAGE	6
START-UP CHECKLIST	7
ELECTRIC STARTING	7
REMOTE STARTING	7
CONNECTING THE LOADS	8
UNIT STORAGE	8
50 CYCLE OPERATION	8
MAINTENANCE	9
PREVENTIVE MAINTENANCE	9
WIRING DIAGRAMS	
DC ELECTRICAL SCHEMATIC	10
RECEPTACLE PANEL	11
CIRCUIT BREAKER PANEL	11
CONTROL PANEL	12
CONTROL PANEL WIRING DETAIL	13
AC SCHEMATIC	14
AC WIRING DIAGRAM	15
WARRANTY	16

GUIDE TO PRODUCT SAFETY

This engine generator set has been designed and manufactured to insure your personal safety. Improper use can result in potential deadly hazards, from electrical shock, exhaust gas asphyxiation, or fire. Please read all safety instructions carefully before installation or use. Keep these instructions handy for future reference. Take special note and follow all warnings on the unit and in the manuals.

CAUTION: Possible Damage to Equipment.
CAUTION notes indicate any condition or practice, which if not strictly observed or remedied, could result in damage or destruction of the equipment.

WARNING: Personal Danger.
WARNING notes indicate any condition or practice, which if not strictly observed, could result in personal injury or possible loss of life.

1. **ELECTRIC SHOCK** - The output voltage present in this equipment can cause a fatal electric shock. This equipment must be operated by a responsible person.
 - A. Do not allow anyone to operate the generator without proper instruction.
 - B. Guard against electric shock.
 - C. Avoid contact with live terminals or receptacles.
 - D. Use extreme care if operating this unit in rain or snow.
 - E. Use only three-prong grounded receptacles and extension cords.
 - F. Be sure the unit is properly grounded to an external ground rod driven into the earth.
2. **FIRE HAZARD** - Diesel fuel and other fuels always present a hazard of possible explosion and/or fire.
 - A. Do not refuel when the engine is running or hot. Allow the engine to cool at least two minutes before refueling.
 - B. Keep fuel containers out of reach of children.
 - C. Do not smoke or use open flame near the generator set or fuel tank.
 - D. Keep a fire extinguisher nearby and know its proper use. Fire extinguishers rated ABC by NFPA are appropriate.
 - E. Store fuel only in an approved container, and only in a well-ventilated area.
3. **DEADLY EXHAUST GAS** - Exhaust fumes from any internal combustion engine contain carbon monoxide, an odorless and deadly gas that must be mixed with fresh air.
 - A. Operate only in well ventilated areas.
 - B. Never operate indoors.
 - C. Never operate the unit in such a way as to allow exhaust gases to seep back into closed rooms (i.e.

through windows, walls or floors).

4. **NOISE HAZARD** - Excessive noise is not only tiring, but continual exposure can lead to loss of hearing.
 - A. Use hearing protection equipment when working around this equipment for long periods of time.
 - B. Always operate with the housing doors closed to reduce the operational noise level.
5. **CLEANLINESS** - Keep the generator and surrounding area clean.
 - A. Remove all grease, ice, snow or materials that create slippery conditions around the unit.
 - B. Remove any rags or other material that could create potential fire hazards.
 - C. Carefully wipe up any gas or oil spills before starting the unit.
 - D. Never allow leaves or other flammable material to build up around the engine exhaust area.
6. **SERVICING EQUIPMENT** - All service, including the installation or replacement of service parts, should be performed only by a qualified technician.
 - A. Use only factory approved repair parts.
 - B. Do not work on this equipment when fatigued.
 - C. Never remove the protective guards, cover or receptacle panels while the engine is running.
 - D. Never wear neckties or other loose clothing that can be caught in moving parts while you are servicing or operating this equipment.
 - E. Use extreme caution when working on electrical components. High output voltages from this equipment can cause serious injury or death.
 - F. When servicing this unit always avoid hot mufflers, exhaust manifolds, and engine parts. They all can cause severe burns instantly.
 - G. Installing and wiring a standby generator is not a "do it yourself" project. Consult a qualified, licensed electrician or contractor. The installation must comply with all national, state, and local codes.
7. **LIFTING THE EQUIPMENT** - When lifting always make sure that the area under the equipment is kept clear.
 - A. Be certain rigging is designed to lift unit safely.
 - B. Never attempt to lift the equipment unless you are certain the lifting device has sufficient capacity.
 - C. Never allow the equipment to swing while suspended.
 - D. Be certain the supporting structure is adequate to handle the load.
8. **TOWING THE EQUIPMENT** - When towing this equipment always use a vehicle large enough for safe operation.
 - A. Never tow without the safety chains secured.
 - B. Always use the proper size hitch ball on the vehicle.
 - C. Never attempt to tow with a vehicle that does not have side mirrors installed.

SPECIFICATIONS

GENERATOR SPECIFICATIONS

MDS50

KILOWATT	40 kW
KILOVOLT-AMPS	(.8 PF)50.0 KVA
AMPERAGE	277/480 VOLT 3 PHASE 60.2 AMPS*
	120/240 VOLT 3 PHASE 120.4 AMPS*
	120/208 VOLT 3 PHASE 139 AMPS*
	120/240 VOLT 1 PHASE 166.7 AMPS

*Based on .8 power factor at 130 degrees C.

Derate 3% per 1000 feet (305 meters) between 300 feet (90 meters) and 7,500 feet (2,286 meters) above sea level. Contact the factory for rating data for operation in altitudes above 7,500 feet (2,286 meters).

GENERATOR RESISTANCE'S

MDS50

Main Stator	.075 ohms
Main Rotor	3.6 ohms
Exciter Stator	25 ohms
Exciter Rotor	.035 ohms
Exciter Voltage (F1-F2)	
No Load	9.5 VDC
Full Load	39 VDC
Exciter Amperage (F1-F2)	
No Load	.4 Amps
Full Load	1.3 Amps

ENGINE SPECIFICATIONS

See John Deere Operation and Maintenance Manual for complete engine specifications.

TRAILER/HOUSING

MDS50

Capacity	5000 lb.
Fuel Capacity	80 gals
Axles	Single
Hitch Height	Adjustable
Tires	P225/75-15
Tire Pressure	35 psi
Sound Attenuated	ULTRA QUIET
Housing	Housing Standard

PREPARATION

NOTE: This booklet covers the entire unit, EXCEPT THE ENGINE. See the engine manufacturer's operator manual for specific maintenance and care information regarding the engine. Read ALL instructions in the manuals provided before attempting to operate the generator set.

UNPACKING

When receiving the unit, be sure to inspect it carefully for freight loss or damage. Check the nameplate to be sure it is what you ordered (proper kW, voltage, fuel, etc.). If you have questions, contact your local authorized dealer. If you see evidence of loss or damage at the time of delivery, have the driver sign and describe the loss or damage in the "memo of loss or damage" section on the freight bill. Then contact the carrier to get instructions on filing a claim.

When loss or damage is discovered after the equipment is delivered, but not seen at the time of delivery, it is referred to as "concealed damage." Separate any damaged material and contact the carrier for proper procedures to file a "concealed damage" claim.

OIL REQUIREMENTS

This engine was filled at the factory with John Deere Engine Break-In Oil. This break-in oil should be drained and the oil filter changed after the first 100 hours of operation.

During the break-in period, add John Deere Engine Break-In Oil as needed to maintain the specified oil level.

A second 100-hour service interval with John Deere Engine Break-In Oil may be required if the engine is operated under light loads during the first 100 hours.

After the break-in period, use John Deere Torq-Grad Supreme Plus-50 or other heavy -duty diesel engine oil as recommended in the John Deere Engine manual. See your engine operator's manual for recommended oil grades and types under different operating temperatures.

OIL QUANTITY

US Qt. Liters

MDS50	9.0	8.5
--------------	-----	-----

FUEL REQUIREMENTS

See your engine operator's manual for complete type and grade fuel information.

Filling the Fuel Tank

Standard Trailer - The standard trailer is equipped with a single 80 gallon fuel tank. Use caution when filling the tank not to overflow the tank into the trailer.

WARNING PERSONAL DANGER

Never refuel a running engine,. Always stop the engine and allow to cool before refueling.

Never allow the fuel tank to run completely empty, as air may enter the fuel system making it necessary to bleed the engine when restarting.

COOLANT REQUIREMENTS

The cooling system of this engine has been filled at the factory with a 50% water and 50% ethylene-glycol antifreeze and the proper amount of supplemental coolant additives. This mixture provides protection to -37 degrees F.

When replenishing coolant or changing coolant refer to your John Deere engine manual for the proper type and mixture of water, antifreeze and supplemental coolant additives.

WARNING: EQUIPMENT DAMAGE

Failure to properly follow John Deere's requirements for antifreeze and supplemental coolant additives can lead to permanent damage to your engine cylinder liner walls.

COOLANT QUANTITY	US Gal	Liters
MDS50	6.67	25.3

BATTERY CONNECTION INSTRUCTIONS

WARNING! EQUIPMENT DAMAGE

FAILURE TO PUT THE ENGINE CONTROL SWITCH IN THE 'OFF' POSITION PRIOR TO CONNECTING THE BATTERY CABLE(S) MAY RESULT IN DAMAGE TO THE ECM. (SOLID STATE ENGINE CONTROL MODULE).

The MDS50 requires a customer supplied 12 volt group 27 battery with minimum 675 CCA. A battery mounting kit has been supplied loose with the unit. When connecting the battery, ALWAYS CONNECT THE POSITIVE CABLE FIRST and THE NEGATIVE CABLE LAST! Disconnecting the battery is done in reverse, disconnecting the negative cable first and then the positive cable.

WARNING - POTENTIAL BATTERY EXPLOSION

THIS UNIT USES A NEGATIVE GROUND. CONNECTING THE NEGATIVE CABLE FIRST MAKES THE BATTERY POSITIVE TERMINAL HOT. CONNECTING THE POSITIVE CABLE LAST MAY RESULT IN ACCIDENTAL SHORT CIRCUIT OF THE POSITIVE BATTERY TERMINAL TO ANY OF THE SURROUNDING METAL SURFACES. (I.E. DROPPING A TOOL, WRENCH SWING ETC.) USE EXTREME CAUTION WHENEVER MAKING OR BREAKING THE BATTERY CONNECTIONS AND FOLLOW THE CORRECT SEQUENCE CAREFULLY.

NEVER ATTEMPT TO JUMP START THIS ENGINE.

If the battery should accidentally become discharged disconnect the battery cables and recharge the battery before attempting to start the unit. Boost/jump starting this unit improperly will result in PERMANENT DAMAGE TO THE ENGINE CONTROL MODULE (ECM).

DESCRIPTION AND IDENTIFICATION

A. FRONT PANEL

1. **Starting Controls** - This unit is equipped for manual or automatic start. A three position switch controls the engine starting.

a. "Off" - This switch position stops the engine and disconnects the power from the engine control module. It is intended to safely allow service and maintenance checks on the engine

b. "RUN" - This switch position engages the start circuitry in the engine control panel. The engine control module goes into a 12 second start delay and then the starter is engaged. The engine control module in the control panel will disengage the starter when the unit starts and engage the engine monitoring sensors.

c. "AUTO" - This switch position is used when the MDS50 is used in a standby mode. With the switch in this position a remote contact (i.e. Automatic Transfer Switch) can be closed to engage the start circuitry. A terminal block has been provided behind the customer connection door for you to wire your remote contact into. This remote contact must close to provide a path between the start wire and battery negative.

2. **DC Control Circuit Breaker (DCCB)** - The 15 amp DC Circuit Breaker protects the engine controller and wiring harness against faults in wiring or control equipment. The DCCB also prevents a discharge of the battery due to a circuit fault.

3. **Emergency Stop Switch** - When depressed this switch will disconnect all the 12 volt power to the engine control panel shutting the engine down. The lamp in the emergency stop switch will light up when the switch is depressed showing that the power to the panel has been disconnected.

4. **Engine Instruments**

a. Oil pressure monitor gauge (OPG) - The oil pressure gauge is mounted on the front control panel and indicates the engine oil pressure. The gauge serves a dual function. In addition to displaying the oil pressure it also provides the shutdown signal to the engine control module if the pressure should drop too low. The shutdown signal is factory preset at 15 psi (103 kPa/m sq).

b. Coolant temperature monitor gauge (CTG) - The coolant temperature gauge indicates engine coolant temperature. The gauge serves a dual function. In addition to displaying the water temperature it also provides the shutdown signal to the engine control module if the water temperature gets too high. The shutdown signal is preset to operate at 225 f (407 k)

c. Battery Voltage Meter - This DC voltmeter monitors the VOLTAGE of the battery under static (at rest) conditions, and under cranking and charging conditions. The voltmeter indicates not only the condition of the charging system, but also indicates the battery reserve under cranking load in cold weather.

d. Running Time Meter - This DC meter records the total hours the engine has run.

5. AC Generator Controls

a. Voltage adjust rheostat - Controls the output voltage of the generator by varying voltage regulators reference voltage.

b. Field circuit breaker (FCB) - Protects voltage regulator and exciter field in the event of a load short circuit or equipment malfunction.

c. Voltage selector power switch - This heavy duty three position switch allows the operator to quickly and safely reconnect the 12 lead generator to any one of three output voltages. Once the output voltage is selected, the switch may be locked to prevent it from accidentally being changed during operation. Three output voltage combinations are available with this selector switch:

1. 120/240 Three Phase* (series Delta configuration)
2. 120/208 Three Phase (Low or Parallel "WYE" configuration)
3. 277/480 Three Phase (High or series "WYE" configuration)

*This selector position is also used for single phase 120/240 output by using only the L1 and L2 leads. The three phase L3 output lead is the "wild" leg in the delta configuration.

6. AC Generator Instruments

a. VM/AM Selector Switch - This selector switch allows you to check the amperage being drawn from each generator leg and your line to line voltage.

b. AC Voltmeter (VM) - Monitors generator output line to line voltage, for all voltage operations.

c. AC Ammeter (AM) - Monitors the amperage that is being drawn from each leg of the generator.

d. AC Frequency Meter - Monitors the generator frequency.

7. **Warning Light Cluster** - This light cluster contains the indicator lamps for the four engine shutdowns controlled by the engine control module. The lamps will stay lit after a shutdown until the selector switch has been moved to the off position. All the shutdowns are reset when the selector switch is turned off or the DC circuit breaker is turned off.

a. Low Oil Pressure Lamp (LOP) - Indicates that the unit did not maintain a minimum oil pressure of 15 psi.

b. High Water Temperature Lamp (HWT) - Indicates the coolant temperature in the engine exceeded upper coolant temperature limits.

c. Overspeed Lamp (OS) - Indicates the engine speed exceeded the allowable speed limit while operating. An OS light may also indicate that the ECM has lost its frequency sensing signal (from the engine alternator) during the last run period.

d. Overcrank Lamp (OC) - Indicates the engine tried to start and went through five (5) twelve (12) second crank cycles without starting. Before attempting to restart the unit, first investigate why it didn't start.

8. **Lamp Test Switch** - The lights can be tested by pressing the lamp test switch. When depressed all four lights will come on. As soon as the switch is released the light will go out.

9. **Panel Light** - A panel light is provided for your convenience. It is activated by the panel light switch.

B. RECEPTACLES and CIRCUIT BREAKERS

1. 120 Volt 20 Amp Ground Fault Interputer Duplex. This duplex receptacle is protected by a 20 Amp circuit breaker mounted just above the duplex. With the "T" slot design both 15 and 20 amp 120 volt cords can be plugged in.

2. 120 Volt 20 Amp 3 wire twist lock, NEMA Spec L5-20. This twistlock receptacle is also protected by a 20 Amp circuit breaker. This receptacle is wired in series with the GFCI receptacle which provides it with GFCI protection.

3. 240 Volt 20 Amp 3 wire twist lock, NEMA Spec L6-20. This twistlock receptacle is protected by a two pole 240 volt circuit breaker.

4. 120/240 Volt 50 Amp 4 wire twistlock. This receptacle is rated for dual voltage, 120 or 240 volt use. It is a

four wire receptacle, with a center grounding pin. Four wire drop cords plugged into this receptacle may be split into 120 volt receptacles at a distribution box. This receptacle is protected by a two pole 50 amp circuit breaker mounted just above it. THIS RECEPTACLE UTILIZES A SPECIAL HUBBELL PLUG.(HUBBELL PART NUMBER "CS 6365".)

C. FULL POWER LOAD CONNECTIONS and BREAKERS

This Mobile Diesel Power System is equipped with both high voltage (480) and low voltage (208/240) main line breakers. The breakers are interlocked with a lockable bar to insure that only one breaker can be turned on at a time.

A full power output terminal block is provided. This terminal block is located below the main power breakers and is accessible through the access door located just below the main line breakers. If this access door is opened with the unit running a safety switch will disable the 12 volt system shutting the unit down. This door must remain closed and latched at all times during normal operations.

DANGER: PERSONAL INJURY

This unit will start as soon as the door is closed if the start switch is in the run position. Do not use the switch on this door to shutdown a unit to connect to the full load terminal block , this is a safety switch only.

D. ENGINE CONTROL MODULE (ECM)

The ECM is a microprocessor based module that controls the complete unit. It monitors all the engine safety sensors such as oil pressure, water temperature, overspeed, and overcrank and shuts the unit down should any one of the sensor circuits show a fault.

1. Control Switch Inputs

The following front panel controls and instruments are wired into the microprocessor through the ECM terminal blocks.

- a. Run-Off-Auto switch:
 1. "Run" - This is your local operation position. In this position the engine will start immediately.
 2. "Off" - position prevents unit operation by disconnecting all power to the ECM.
 3. "Auto" - position powers up the ECM in a standby mode. A remote switch closure is required to activate the start circuits.

2. Safety Inputs:

a. Low oil pressure shutdown -(LOP)- Monitoring of oil pressure begins 12 seconds after the unit starts, and remains in effect until unit is shutdown by normal control circuits (except as noted in "loss of frequency input" below). The 'LOP' signal is derived from an oil pressure gauge mounted in the engine control panel.

b. High water temperature shutdown -(HWT)- The engine coolant sensor temperature monitoring begins immediately with the start signal. If water temperature is excessive at time of start, (i.e. heat soak after shutdown), the unit is still permitted to start. The 'HWT' condition is permitted to exist for up to 60 seconds after the unit initially starts before a shutdown WITH ALARM occurs. If the excessive water temperature condition is corrected within the initial 60 second period, the 'HWT' circuit begins normal monitoring of the engine temperature and the 'safety shutdown' circuit is reactivated. The 'HWT' signal is derived from a temperature gauge mounted in the engine control panel.

c. Overspeed adjustment -(OS)- Overspeed protection is provided by a frequency sensing network within the controller. The trip point of the frequency network is adjustable via a rheostat located in the center of the controller. The adjustment is accessed through the small hole in the center of the engine control module.

NOTE: Use a plastic or non-metallic screwdriver when making any adjustment to the overspeed. Clockwise (CW) rotation increases the tip frequency, and thereby raises the shutdown speed. The frequency input is obtained from the engine battery charging alternator.

d. Overcrank -(OC)- The MDS65 is designed to use cycle cranking. This feature provides a series of five cranking cycles lasting 12 seconds with a 12 second rest period between each. Failure of the engine to start by the end of the fifth crank period results in an "overcrank" shutdown and alarm indication.

3. Cranking Disconnect Signal

The cranking disconnect signal is obtained from the frequency sensing network within the controller. The trip point of the crank disconnect is not directly adjustable but is a percentage of the overspeed adjustment.

4. E.C.M. - Program Notes

a. Loss of frequency input - In the event the input frequency goes to zero (engine runs out of fuel, battery charging alternator fails, etc.), the LOP shutdown circuit is by-passed, and a 12 second wait period is initiated. If frequency returns within this time period, LOP monitoring resumes and operation continues normally. If frequency

has not returned at the end of this time period, the engine oil pressure status is observed to determine whether the engine is actually running or stopped. If the engine has stopped (i.e.- air in fuel, etc., the unit is shut down with an “overspeed” indication and alarm.

b. “Overspeed” indicator light can mean a loss of control signal during the previous run period (i.e.- bat. charging alternator belt broken).

TROUBLE SHOOTING HINT: This is of particular note since the tendency is to pursue only overspeed faults. The overspeed signal source (battery charging alternator) is a key component in this system and must be checked out thoroughly whenever an “OS” shutdown occurs.

Please note: The controller does not provide protection against loss of signal during start-up. A shutdown with alarm due to any of the above conditions will prevent any subsequent operation of the generator set. The control switch on the control panel must be momentarily placed in the “off” position to reset.

E. VOLT/HERTZ VOLTAGE REGULATOR

The purpose of the voltage regulator is to maintain the voltage output of the Generator Set within a specified percentage of its rated output from no load to full load. The voltage regulator controls the voltage output of the main generator by regulating the amount of current delivered to the exciter field.

- 1. Location** -Access to the voltage regulator assembly is gained by removing the control panel access door located through the left rear housing door.
- 2. Description** - The Basler model VR63-4C voltage regulator is a completely encapsulated unit. The regulator controls the DC exciter field voltage on brushless generators to regulate the output voltage. Regulation is provided by sensing the generator output voltage, converting it to a DC signal and comparing the signal to a reference voltage signal. An error signal is developed and used to control the DC field power in order to maintain a constant generator output.

3. Operation of Voltage Regulator - The voltage regulator has been installed in the Mobile Diesel Generator set and tested at the factory prior to shipment. No additional set-up is required when changing from one voltage to another. The only adjustment required is to fine tune the exact voltage you want using the voltage adjustment rheostat located on the front panel. The adjustment range is 10% of the nominal voltage.

Some minor changes must be made for 50 cycle operation. Refer to 50 Hz operation later in this section for set-up procedures.

a. During periods of operation at reduced speed use the field circuit breaker to remove the power from the regulator.

b. If the exciter field voltage exceeds 95 VDC, the regulator senses over excitation and automatically removes the field current after a time delay. This time delay is inversely proportional to the magnitude of the detected over voltage condition. At approximately 140 VDC, the field voltage is removed instantaneously.

Upon detection of over excitation and the resulting field voltage shutdown, the regulator will not reset or return to an operational condition until the generator output voltage drops to less than 6 VAC for ten seconds (minimum). TO ACCOMPLISH THIS ON A MOBILE DIESEL GENERATOR SET THE FIELD CIRCUIT BREAKER MUST BE TURNED OFF FOR TEN SECONDS.

OPERATING THE UNIT

A. SELECTING THE CORRECT VOLTAGE

A variety of voltages are available from the three position selector switch. The three basic connection patterns are, Delta (120/240), Low or Parallel WYE (120/208), and High WYE (277/480). Single phase 120/240 is available with the switch in the 120/240 (Delta) position.

Before connecting this unit to a distribution panel or any other loads, be sure you have the selector switch set for the right voltage and locked. If you have any doubts as to the voltage in your area compare your incoming power or load name plates to the voltage table below.

1. 120/240 Three Phase* (Delta/Series configuration) - This configuration will produce the following line-to-line and line-to-neutral voltage. In this selector switch position, all of the receptacles on the front panel are powered.

L1 - L2 - L3 240 Volts three phase
L1 - L2 240 volts single phase
L2 - L3 240 volts single phase
L1 - L3 240 volts single phase
L1 - N 120 Volts
L2 - N 120 Volts
L3 - N 208 volts

*This selector position is also used for single phase 120/240 output, using only the L1 and L2 leads. The L3 three phase output lead is the “wild” leg in the delta configuration and is used only for three phase loads.

2. 120/208 Three Phase (Low/Parallel WYE configuration) This configuration will produce the following line-to-line and line-to-neutral voltage. Use of this selector switch position allows utilization of the 120 volt receptacle

only. The 240 volt receptacles cannot be used as the voltage at them will be 208 volts, the line to line voltage.

L1 - L2 - L3 208 Volts three phase
L1 - L2 208 volts single phase
L2 - L3 208 volts single phase
L1 - L3 208 volts single phase

L1 - N 120 Volts
L2 - N 120 Volts
L3 - N 120 volts

3. **277/480 Three Phase** (High/Series WYE configuration) This configuration will produce the following line-to-line and line-to-neutral outputs. The 120 volt receptacles are the only panel receptacles powered in this voltage configuration. They are limited to 12 Amps total.

L1 - L2 - L3 480 Volts three phase
L1 - L2 480 volts single phase
L2 - L3 480 volts single phase
L1 - L3 480 volts single phase
L1 - N 277 Volts
L2 - N 277 Volts
L3 - N 277 volts

After you have selected the correct voltage for your application and locked the selector switch, do the same with the main line circuit breakers. Be sure to secure the lock bar in place. This will prevent the incorrect breaker from being turned on.

B. STARTUP CHECKLIST

Before initial start up and each subsequent start complete the following checklist:

1. Check oil level, refill with proper grade oil.
2. Check coolant level, refill with proper mixture of coolant. See engine manual.
3. Check for loose bolts or hardware.
4. Check tire pressure. (35 psi)
5. Trailer level to within 15 degrees.
6. Battery securely fastened, connection clean and tight, and proper fluid level.
7. Fuel tank filled with the proper grade of diesel fuel.
8. Check the fan belt for tightness and excessive wear.
9. Check hoses and clamps for leakage.
10. Check the air cleaner indicator. Service only when indicated. Do not over-service.
11. Clean out dust cup on the air cleaner.

C. ELECTRIC STARTING

(Normal portable use)

CAUTION: EQUIPMENT DAMAGE

DO NOT ATTEMPT TO JUMP/BOOST START THIS UNIT. TO DO SO MAY DAMAGE THE ELECTRONIC MICROPROCESSOR IN THE ENGINE CONTROL. TURN THE DC BREAKER "OFF" AND RECHARGE THE BATTERY WITH A BATTERY CHARGER.

1. Select the desired voltage on the voltage selector switch and lock in place.
2. Turn off both main line circuit breakers.
3. Turn the control switch to the "run" position. In this position the unit will go into an automatic start routine. The control goes into a start delay and the starter will engage 12 seconds later. The starter will automatically disengage as the engine comes up to proper operating speed.
4. After the engine is running at proper speed, adjust the voltage to the desired level using the external voltage rheostat.
5. Turn on the proper main line breaker (either high or low voltage) and padlock the lock bar to prevent the incorrect breaker from being turned on.

D. REMOTE STARTING AND CONNECTION

(Standby applications)

1. Complete the manual starting procedure above to insure the system is set up properly.
2. Insure the start switch is in the "off" position during installation of the remote start connections.
3. Locate the remote start terminal block. This terminal block is located next to the full power connections, behind the access door at the bottom of the control panel.
4. Locate the remote start terminals in your remote automatic transfer switch (ATS). The ATS terminal block and wire numbers will vary with each ATS manufacturer. The MDS50 requires a contact closure for start.

WARNING: EQUIPMENT DAMAGE

THE REMOTE "SIGNAL" MUST BE A "DRY" (NON-POWERED) CONTACT CLOSURE. USING A POWER CONTACT WILL CAUSE PERMANENT DAMAGE TO THE ENGINE CONTROL MODULE.

5. For most installations sixteen gauge wire is sufficient to handle the control signal. On extremely long runs increase wire size to minimize voltage drop.
6. Locate the neutral and full power output load connection terminal on the generator.

7. Locate and identify the “neutral” and “generator” connections in the automatic transfer switch.

8. Connect the load block to the transfer switch using the proper wire sizes. Refer to the National Electric Code Handbook (NFPA 70) for proper wire type and sizing. Use Table 310-16 for wiring run through conduit and table 310-17 for free air wiring.

Use extreme caution when installing the delta voltage pattern. One power leg of this 3 phase pattern produces 208 volts measured from line to neutral. Be sure to match the location of the generator wild leg to the location of the wild leg on the incoming power service. Failure to do so will cause equipment damage to any 120 volt load incorrectly connected to this line.

9. Connect the neutral to the transfer switch using the same wire size.

10. For isolated neutral operation remove the jumper wire between the ground lug and neutral connection block.

11. Ground the Mobile Diesel generator set using an 8 ft copper ground rod or other approved grounding system. Connect #4 Awg Copper cable from the ground lug on the generator to the ground rod.

12. Set the selector switch on the transfer switch to the “off” position.

13. Move the start switch on the MDS65 to the “RUN” position. The generator set will now start.

14. Check the voltage at the transfer switch. Verify that it matches the incoming power line voltage line-to-line and line-to-neutral on each leg.

15. Check the three phase rotation pattern. Insure that you have the same rotation, with both the generator and the normal power source.

16. Move the start switch on the MDS50 to the “STOP” position. Let the unit stop and then move the switch to the “AUTO” position. This is the normal position for the switch to be in for automatic start operations.

17. Move the selector switch on the transfer switch to the “AUTO” position. This is the normal position for the switch to be in for automatic start operation.

18. Use the test switch on the transfer switch or shut off the incoming power to test the complete system. The MDS50 should start up and the transfer switch should transfer the load to the generator.

19. Compare the amperage reading from each leg on the generator and insure that none of the legs is exceeding the nameplate rating on the generator.

20. Upon completion of the test, leave all control mode switches in the “AUTO” position.

21. The system is now ready to start and power the loads should the power fail.

E. CONNECTING THE LOADS

There are two ways the loads may be connected to a Mobile Diesel Generator.

1. **FRONT PANEL** - A variety of receptacles have been provided for your convenience on the front panel. The 120 volt receptacles are powered when the voltage selector switch is in the 120/240 or 120/208 volt position. The 240 volt receptacles (although powered in both positions) are only usable in the 120/240 volt position. In the 120/208 volt position the 240 volt receptacles have only 208 volts at them.

2. **FULL POWER LOAD CONNECTION TERMINAL BLOCK** - For remote connections and connecting load distribution boxes, heavy duty terminal blocks have been provided. These terminal blocks are located on the rear of the unit just below the main line circuit breakers. The neutral and ground are connected together at this panel. For use with an isolated neutral, remove the jumper strap between the neutral connection block and the ground lug. This will isolate the neutral from the ground and allow you single point grounding at a distribution panel. When using these terminal blocks be sure to use wire rated large enough to carry your full load or the full rated load of the generator.

3. **GROUNDING THE UNIT** - To comply with current safety standards this generator set must be properly grounded. Ground the Mobile Diesel generator set by driving an 8 ft copper ground rod into the earth. Then connect a #4 AWG ground cable from the grounding lug on the generator to the ground rod.

F. UNIT STORAGE

Certain precautions must be taken if a mobile Diesel Generator set is to be stored for a long period of time. The unit must be stored in a dry location to prevent the generator winding from drawing moisture. The unit should also be thoroughly cleaned prior to storage.

For engine storage procedures consult your local John Deere engine dealer. They have certain procedures that must be followed in order to prevent engine damage, i.e. cylinder rust and injector deterioration.

50 CYCLE (HZ) OPERATION

With a couple of minor changes these Mobile Diesel Generators are capable of producing 50 Hz power. Two changes must be made.

A. The engine must be reduced to 1500 RPM governed speed. Consult your local John Deere Service center for the proper procedure for reducing the engine speed and setting up the governor to operate at 1500 RPM.

B. The automatic volt/hertz regulator must also be reset to operate at 50 HZ instead of the standard 60 HZ. This is done by cutting the two leads marked HZ that come out of the regulator. This will change the regulator for 60 HZ operation to 50 HZ operation. If it should become necessary to change it back to 60 HZ, you would need to splice the leads together again.

MAINTENANCE

The ultimate aim of a preventive maintenance program is to maintain the equipment in optimum condition, either in service or ready for service, for the maximum amount of time during the useful life of the equipment. The detection of faults before they develop into major sources of difficulty will decrease the incidence of repair. To this end, a regular schedule of cleaning and inspection will go far toward assuring trouble-free operation. Personnel responsible for maintenance should set up a schedule for inspection, and cleaning at intervals calculated to keep the equipment in good condition. In making up a schedule, keep the following in mind:

A. New equipment must be carefully monitored until extended operation has demonstrated that it is performing satisfactorily.

B. Old equipment requires more frequent inspection (and possibly servicing) than similar equipment that has seen less service.

C. Time spent in cleaning, inspecting and correcting minor defects before they become major troubles means time saved in overhaul and repair.

PREVENTIVE MAINTENANCE

A. Daily Maintenance Checklist

** Oil level is between the "L" low mark and the "H" high mark on the dipstick.

** Fuel tank full of proper grade of diesel fuel.

** Water and sediment drained from water separator.

** Radiator filled with the proper coolant mixture.

** Check air cleaner service indicator. Change the filter element when the red indicator flag is at the raised position

** Inspect for any fluid leaks

** Look for any loose or damaged parts

** Check belts for cracks or frays

** Check trailer hitch and safety chains for fitness

** Check tires for proper pressure

** Battery for proper fluid level.

** Check the generator control panel for loose or damaged parts.

** Check the unit for general appearance and cleanliness.

DC ELECTRICAL SCHEMATIC

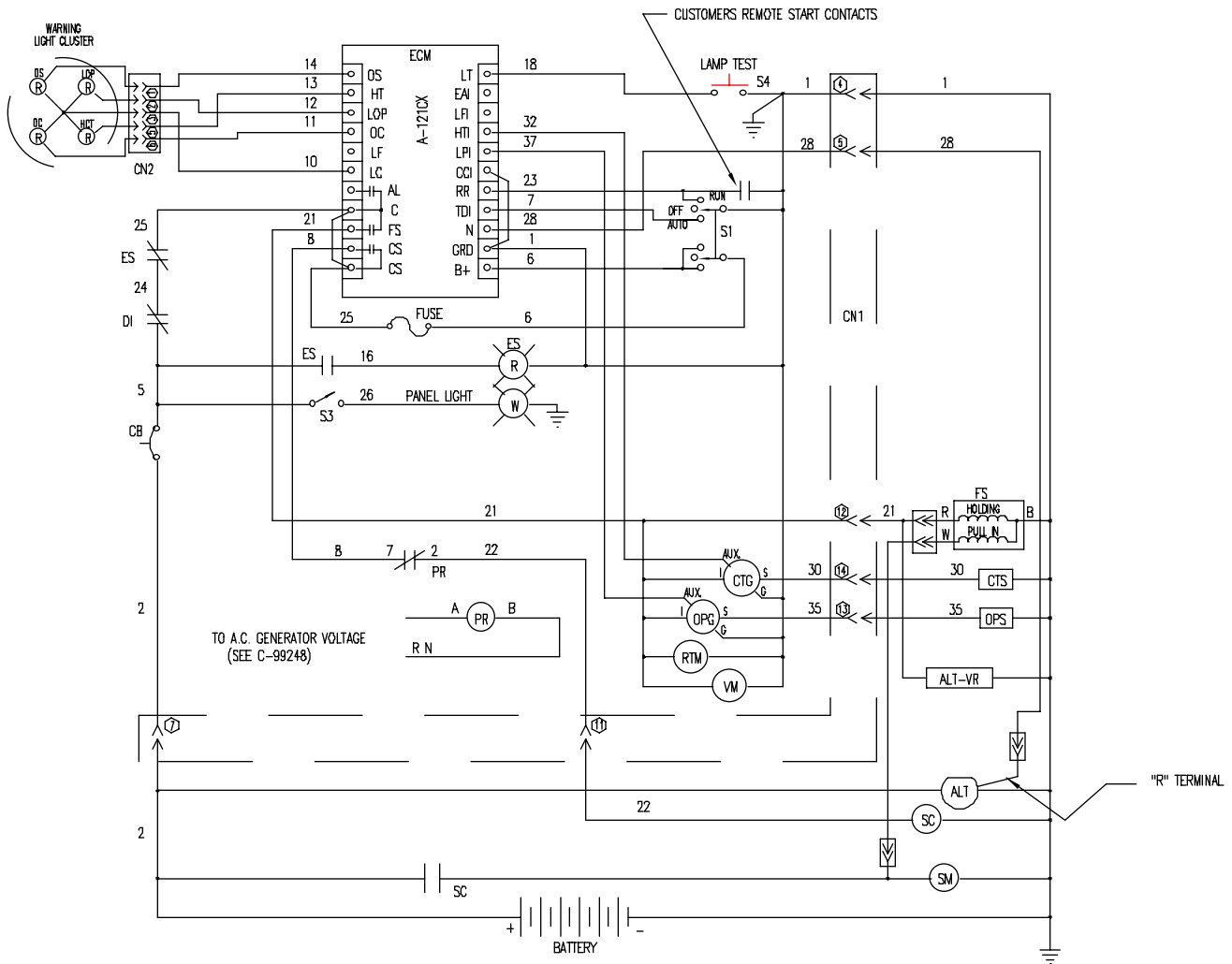

LEGEND

ALT	ALTERNATOR	OPG	OIL PRESSURE GAUGE
ALT-VR	ALTERNATOR VOLTAGE REGULATOR	OPS	OIL PRESSURE SENDER
CB	CIRCUIT BREAKER	OS	OVERSPEED INDICATOR LAMP
CN1	WIRING HARNESS CONNECTORS	PR	PROTECTIVE RELAY, STARTER
CTG	COOLANT TEMPERATURE GAUGE	RTM	RUNNING TIME METER
CTS	COOLANT TEMPERATURE SENDER	S1	ENGINE START MODE SWITCH
DI	DOOR INTERLOCK	S3	PANEL ILLUMINATION LIGHT SWITCH
ECM	ENGINE CONTROL MODULE	S4	ENGINE SHUTDOWN INDICATOR LAMP
ES	EMERGENCY STOP SWITCH	SC	TEST SWITCH
FS	FUEL RACK SOLENOID	SM	ENGINE STARTER MOTOR SOLENOID
GND	GROUND (CHASSIS OR FRAME)	VM	ENGINE STARTER MOTOR
			D.C. VOLTMETER

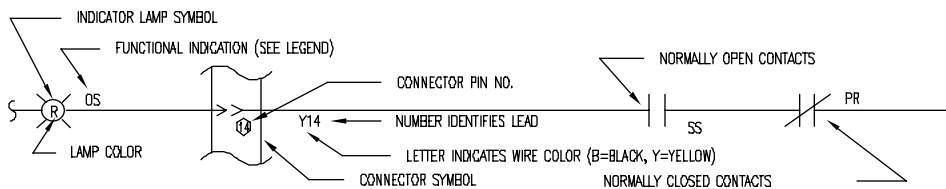

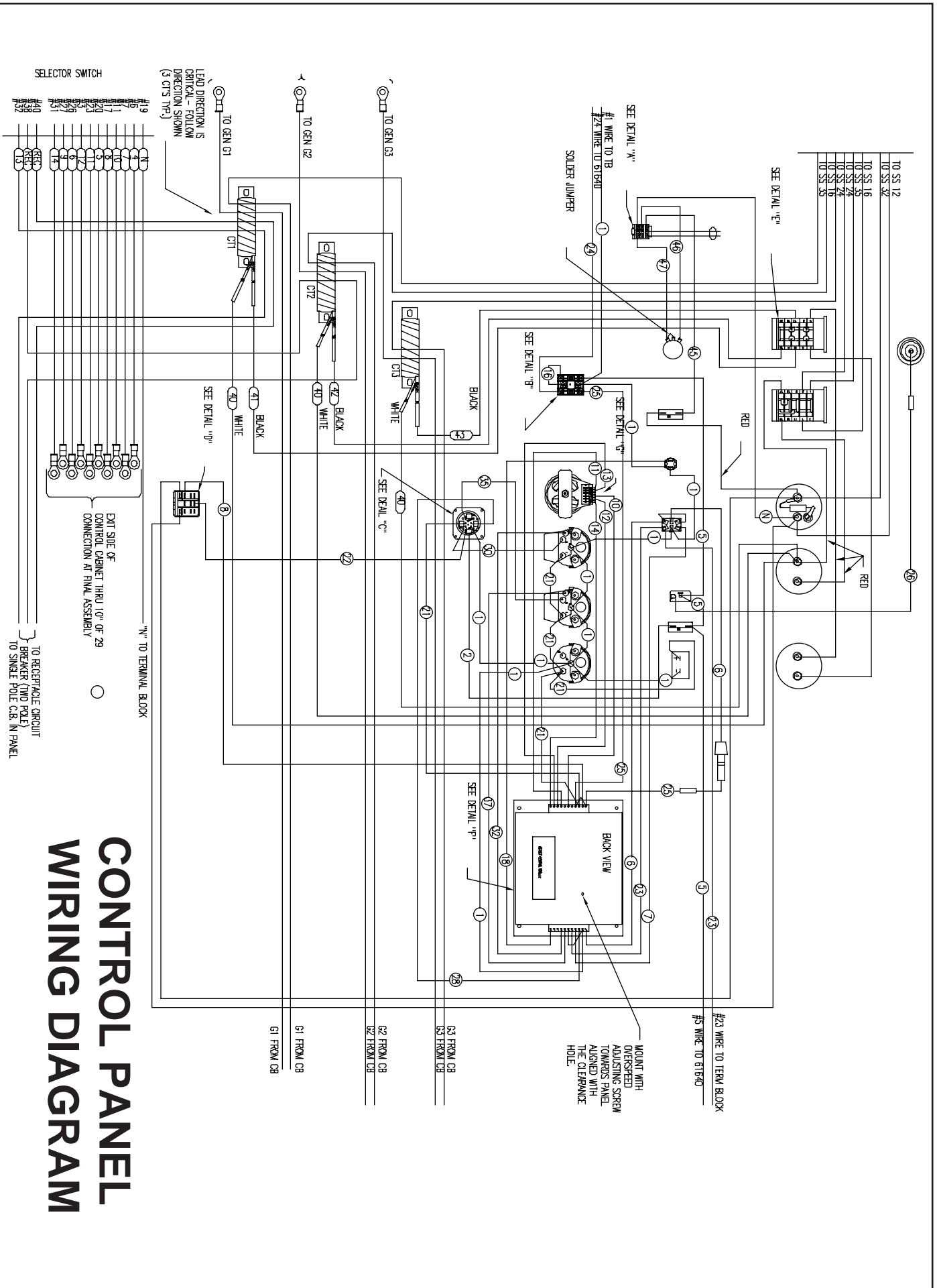

CONTROL PANEL WIRING DIAGRAM

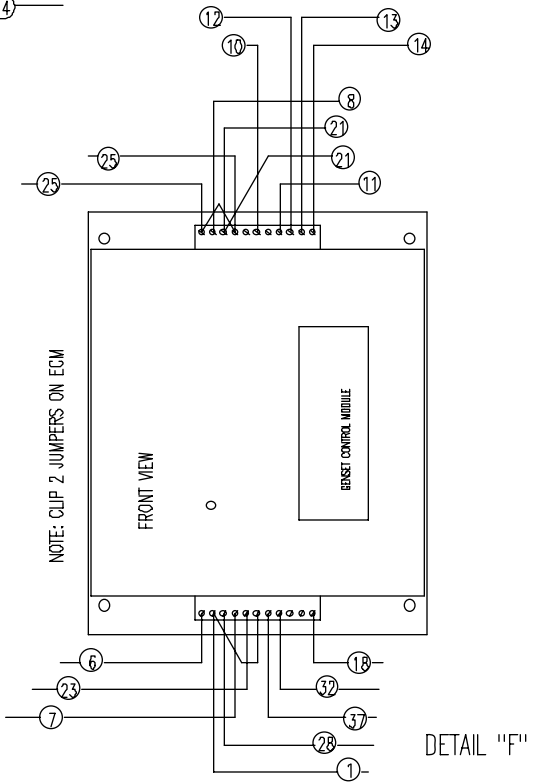
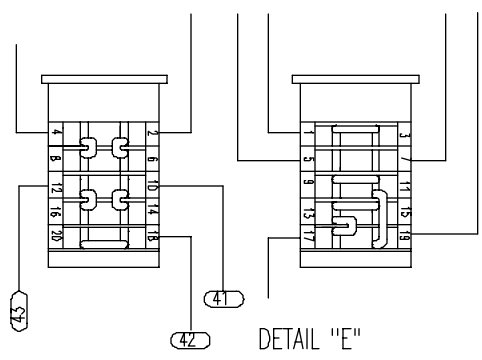
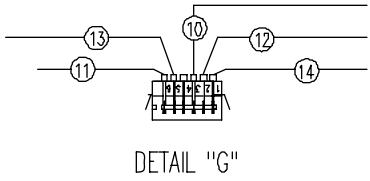
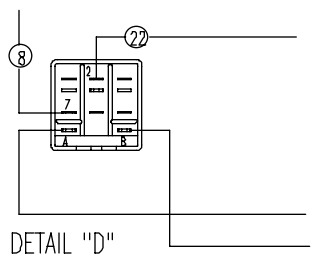
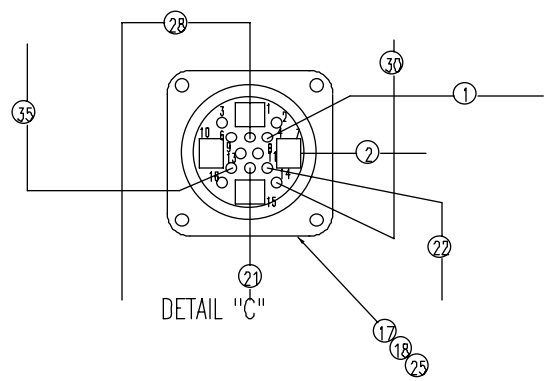
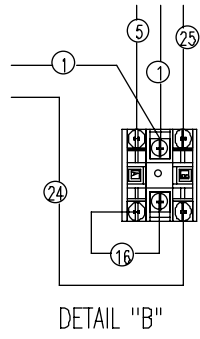
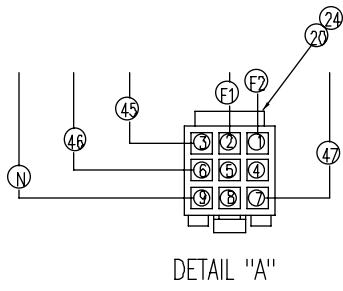

CONTROL PANEL WIRING DETAIL

AC SCHEMATIC

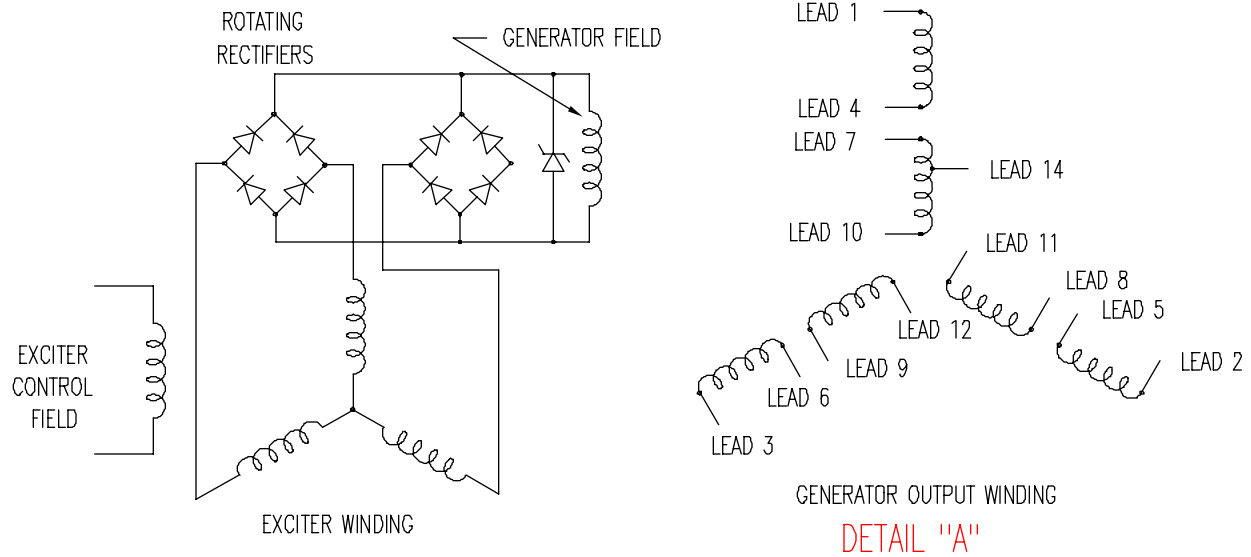

LEGEND

AM	AMMETER
CB	CIRCUIT BREAKER
CN3	WIRING HARNESS CONNECTOR
CT	CURRENT TRANSFORMER
FCB	FIELD CIRCUIT BREAKER
FM	FREQUENCY METER
G	EQUIPMENT GROUND
G1, G2, & G3	GENERATOR POWER LEAD IDENTIFICATION
GVR	GENERATOR VOLTAGE REGULATOR
H	RECEPTACLE POWER TERMINAL
N	GENERATOR NEUTRAL IDENTIFICATION
PR	START SIGNAL DISCONNECT RELAY
S2	VOLTAGE CONFIGURATION SELECTOR SWITCH
S3	VM/AM SELECTOR SWITCH
TB	TERMINAL BLOCK
VM	VOLTMETER
VAR	VOLTAGE ADJUSTMENT RHEOSTAT
W	GENERATOR POWER LEAD IDENTIFICATION
X	GENERATOR POWER LEAD IDENTIFICATION
Y	GENERATOR POWER LEAD IDENTIFICATION

WINCO, INC.

12 Month Limited Warranty

WINCO, Incorporated warrants to the original purchaser for 12 months that goods manufactured or supplied by it will be free from defects in workmanship and material, provided such goods are installed, operated and maintained in accordance with Winco written instructions.

WINCO's sole liability, and Purchaser's sole remedy for a failure under this warranty, shall be limited to the repair of the product. At WINCO's option, material found to be defective in material or workmanship under normal use and service will be repaired or replaced. For warranty service, return the product within 12 months from the date of purchase, transportation charges prepaid, to your nearest WINCO Authorized Service Center or to WINCO, Inc. at Le Center Minnesota.

THERE IS NO OTHER EXPRESS WARRANTY.

To the extent permitted by law, any and all warranties, including those of merchantability and fitness for a particular purpose, are limited to 12 months from date of purchase. In no event is WINCO liable for incidental or consequential damages.

Note: Some states do not allow limitation on the duration of implied warranty and some states do not allow the exclusion or limitation of incidental or consequential damages, so the above limitations may not apply in every instance. This warranty gives you specific legal rights which may vary from state to state.

WINCO reserves the right to change or improve its products without incurring any obligations to make such changes or improvement on products purchased previously.

EXCLUSIONS:

WINCO does not warrant engines, batteries, or other component parts that are warranted by their respective manufacturers.

WINCO does not warrant modifications or alterations which were not made by the WINCO, Inc.

WINCO does not warrant products which have been subjected to misuse and/or negligence or have been involved in an accident.

WINCO®
I N C O R P O R A T E D
225 South Cordova Avenue
Le Center, Minnesota 56057
1-507-357-6821